

ELCS14G-NB2530J6J7293910-F3Y

Received	
<input checked="" type="checkbox"/>	MASS PRODUCTION
<input type="checkbox"/>	PRELIMINARY
<input type="checkbox"/>	CUSTOMER DESIGN
DEVICE NO. : DHE-0003733	
PAGE : 13	

Revised record		
REV.	DESCRIPTION	RELEASE DATE
1	New spec	May.14.2020

ELCS14G-NB2530J6J7293910-F3Y



Features

- Feature of the device : small package with high efficiency
- Typical luminous flux@ 1A : 220 lm
- Optical efficiency@1A : 63.77 lm/W
- Binning Parameters : Brightness, Forward Voltage and Chromaticity
- Grouping parameter: total luminous flux, color coordinates.
- RoHS compliant & Pb free.
- The product itself will remain within RoHS compliant version.
- Compliance with EU REACH.
- Compliance Halogen Free .(Br <900 ppm ,Cl <900 ppm , Br+Cl < 1500 ppm).

Applications

- Mobile Phone Camera Flash(Camera flash light /strobe light for mobile devices)
- Torch light for DV(Digital Video) application
- Indoor lighting applications
- Signal and symbol luminaries for orientation maker lights (e.g. steps, exit ways, etc.)
- TFT backlighting
- Exterior and interior illumination applications
- Decorative and Entertainment Lighting
- Exterior and interior automotive illumination

Device Selection Guide

Chip Materials	Emitted Color
InGaN	Warm White

Absolute Maximum Ratings

Parameter	Symbol	Rating	Unit
DC Forward Current (Torch Mode)	I_F	350	mA
Peak Pulse Current (400 ms on / 3600 ms off / 30000 cycle)	I_{Pulse}	1000	mA
ESD Resistance (JEDEC 3b)	V_B	2	V
Reverse Voltage	V_R	Note 1	V
Junction Temperature	T_J	145	°C
Operating Temperature	T_{Opr}	-40 ~ +85	°C
Storage Temperature	T_{Stg}	-40 ~ +100	°C
Soldering Temperature	T_{Sol}	260	°C
Allowable Reflow Cycles	n/a	2	Cycles
Viewing Angle ₍₂₎	$2\theta_{1/2}$	120	Deg
Thermal resistance	R_{th}	8.5°	C/W

Notes:

1. The CS series LEDs are not designed for reverse bias used.
2. View angle measurement tolerance $\pm 5^\circ$
3. Avoid operating CS series LEDs at maximum operating temperature exceed 1 hour.
4. All specification are assured by reliability test for 1000hr, IV degradation less than 30%.
5. All reliability items are tested under good thermal management with 1.0x 1.0 cm² MCPCB.

JEDEC Moisture Sensitivity

Level	Floor Life		Soak Requirements Standard	
	Time (hours)	Conditions	Time (hours)	Conditions
1	Unlimited	$\leq 30^\circ\text{C} / 85\% \text{ RH}$	168 (+5/-0)	$85^\circ\text{C} / 85\% \text{ RH}$

Electro-Optical Characteristics (Ts=25°C)

Parameter	Symbol	Min.	Typ.	Max.	Unit	Condition
Luminous Flux ⁽¹⁾	I _v	200	220	300	lm	I _F =1000mA
Forward Voltage ⁽²⁾⁽³⁾	V _F	2.95	3.45	3.95	V	
Color Temperature	CCT	2500	2750	3000	K	

Forward Voltage Binning

Bin	Symbol	Min.	Typ.	Max.	Unit	Condition
2939	V _F	2.95	3.45	3.95	v	I _F =1000mA

Luminous Flux Binning

Bin	Symbol	Min.	Typ.	Max.	Unit	Condition
J6	I _v	200	220	300	lm	I _F =1000mA

Notes:

1. Luminous Flux, illuminance measurement tolerance : ±10%
2. Forward voltage measurement tolerance : ±0.1V
3. Electric and optical data is tested at 50 ms pulse condition.
4. Low current voltage measurement tolerance: ±10%
5. Temperature of solder pad : 25°C

Cool White Bin Structure

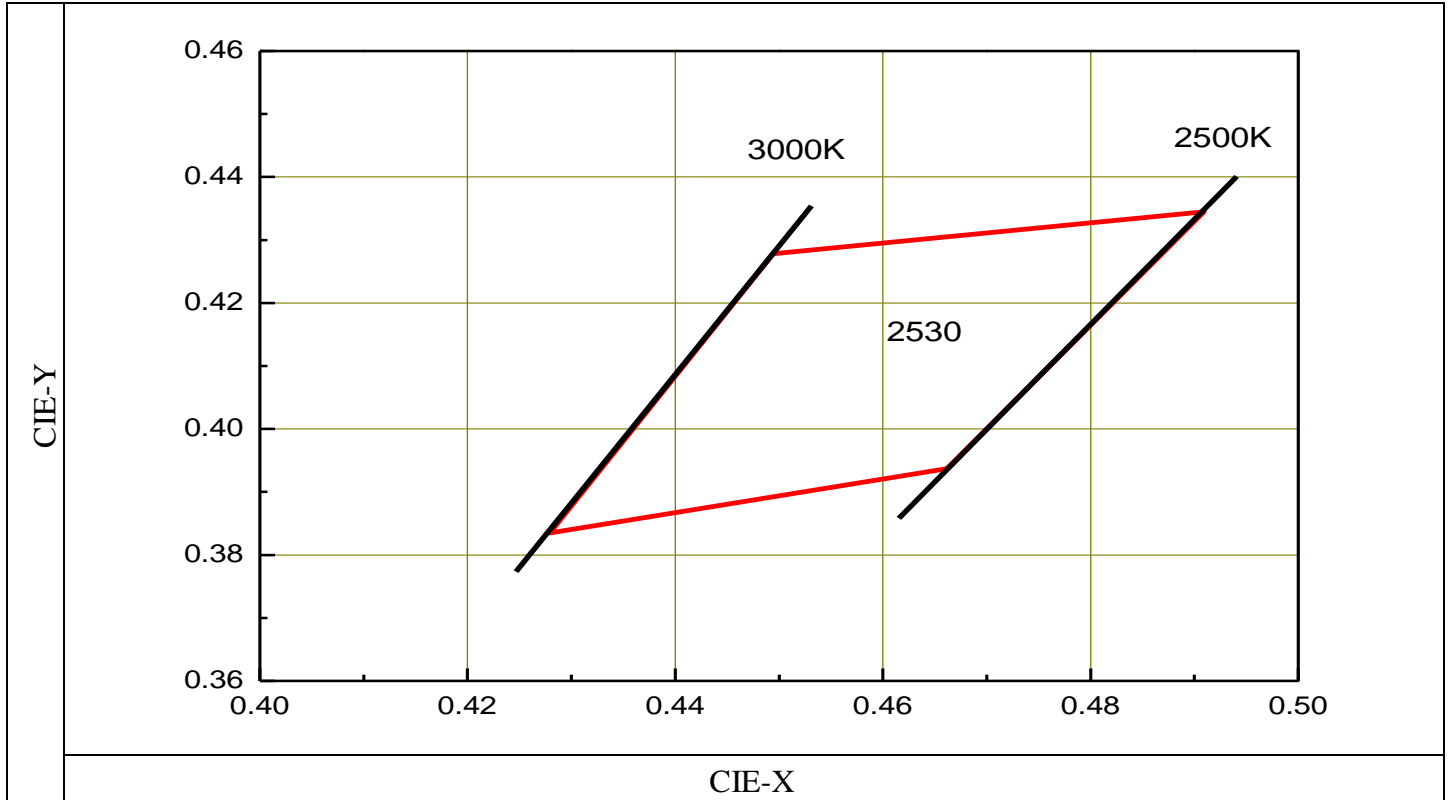

Bin	CIE-X	CIE-Y	Reference Range
2530	0.4494	0.4278	2500 ~ 3000K
	0.4909	0.4345	
	0.4662	0.3937	
	0.4279	0.3835	

Notes:

1. Color coordinates measurement allowance : ± 0.01
2. Color bins are defined at IF=1000mA operation.

Typical Electro-Optical Characteristics Curves

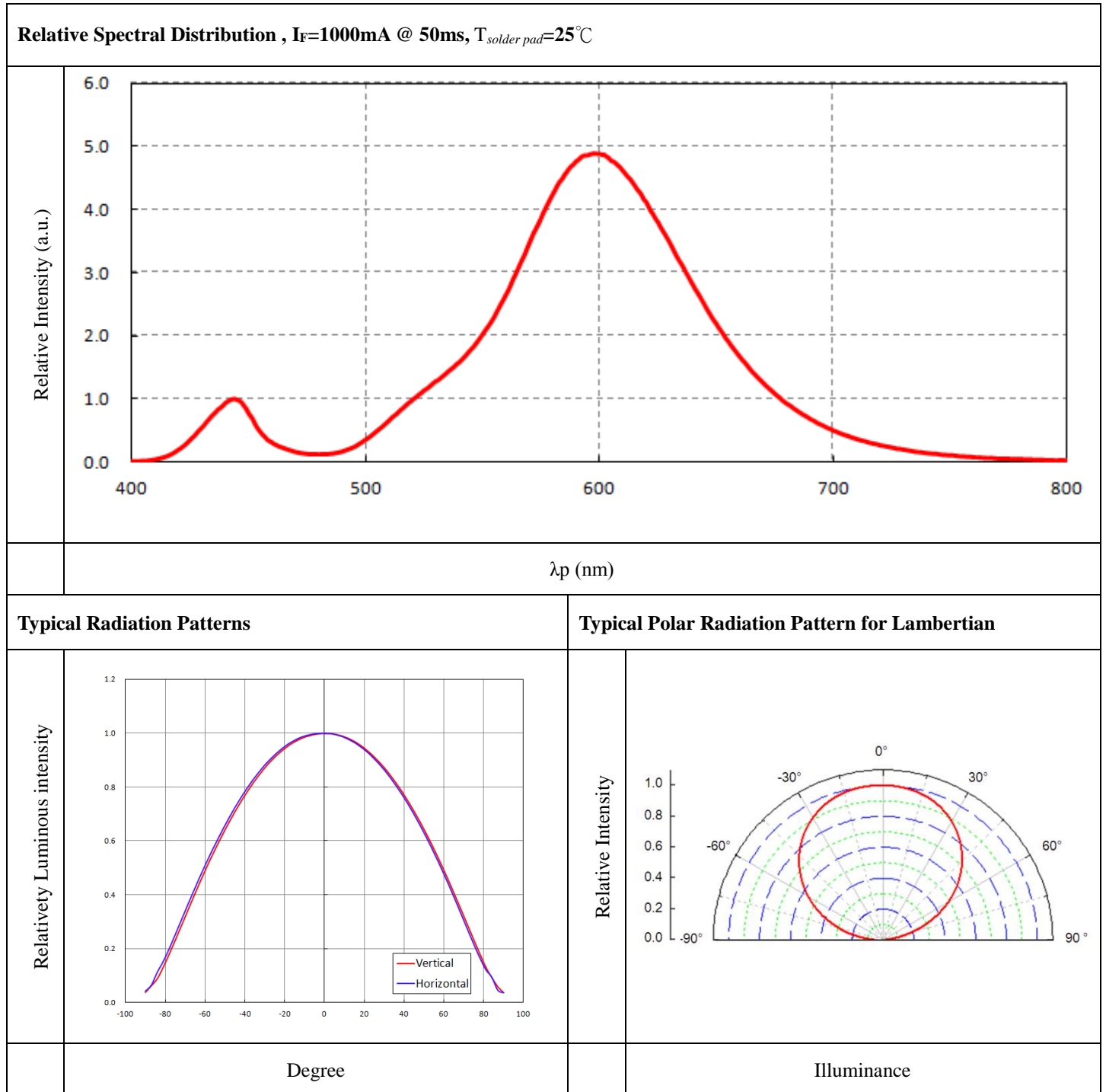

Notes:

1. $2\theta_{1/2}$ is the off axis from lamp centerline where the luminous intensity is 1/2 of the peak value.
2. View angle tolerance is $\pm 5^\circ$

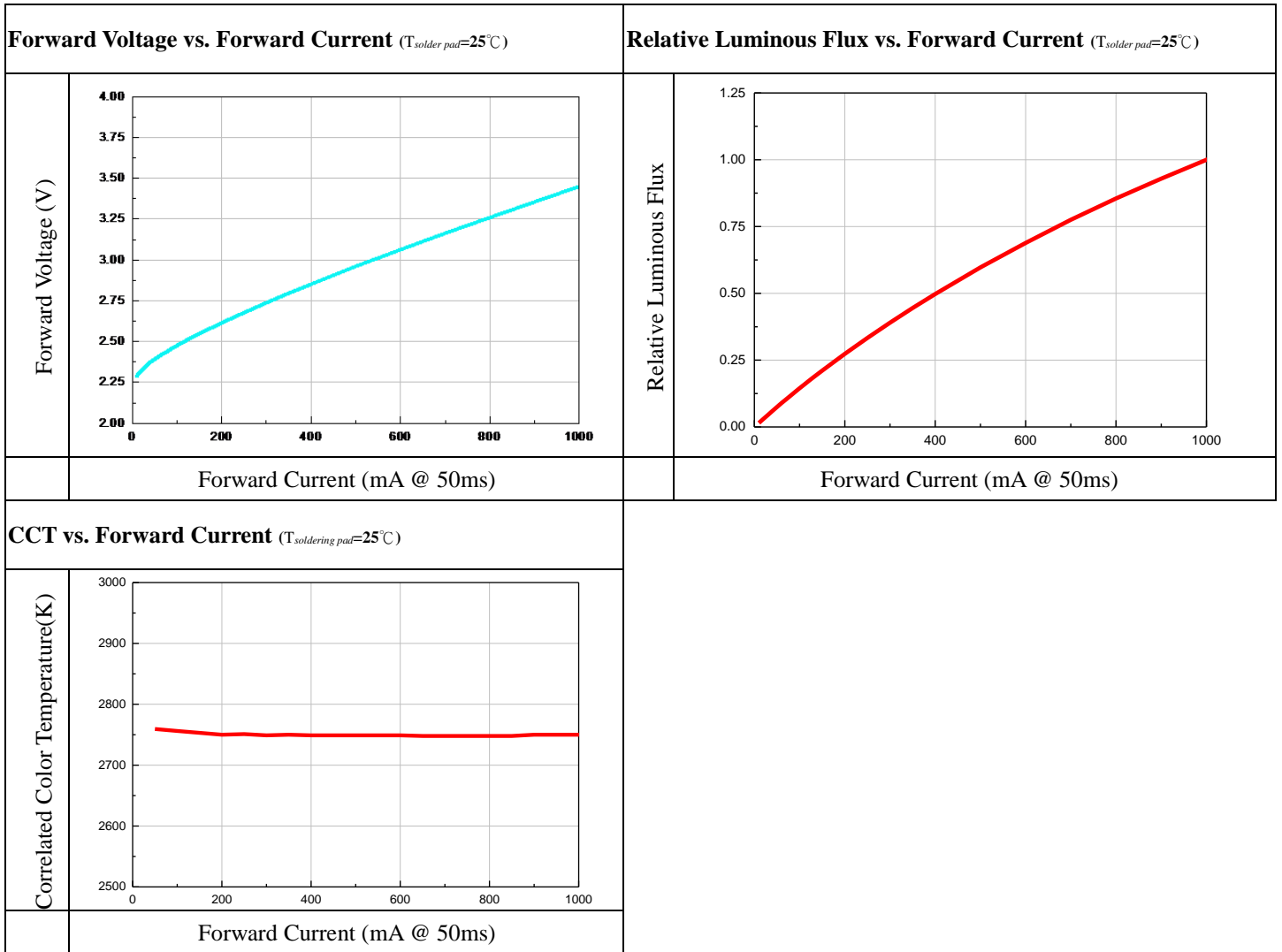

Notes:

1. All correlation data is tested under superior thermal management with 1 x 1 cm² MCPCB.

Package Dimension

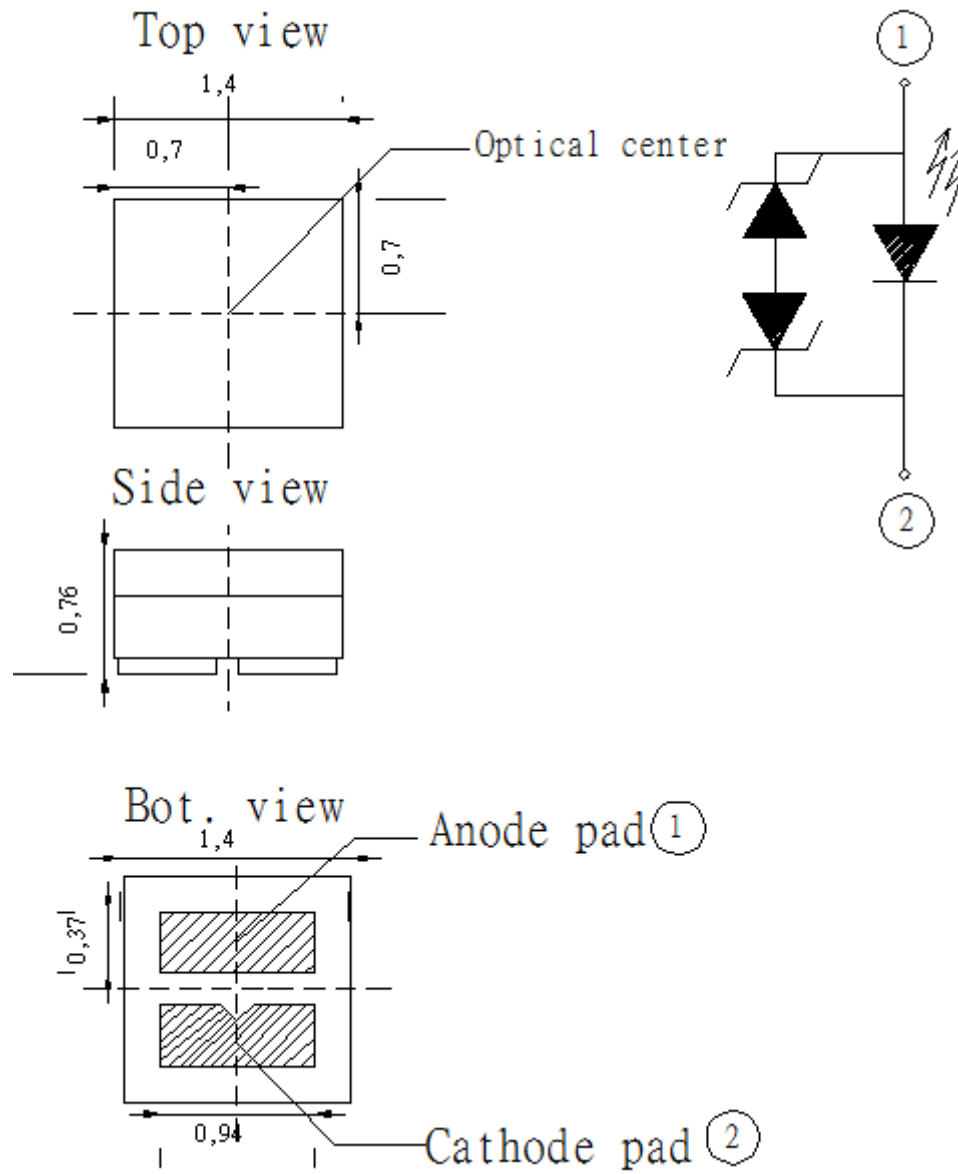

Notes:

1. Dimensions are in millimeters.

Moisture Resistant Packing Materials

Product Labeling

EVERLIGHT

CPN: XXXXXXXXXXXXXXXXXXXX

 XXXXXXXXXXX-XXXXXXXX-XXXXXXXX-XXXXXXXX-XXXXXX
 P/N: XXXXXXXXXXXX

 XXXXXXXXXXX-XXXXXXXX-XXXXXXXX-XXXXXXXX-XXXXXX
 LOT NO:XXXXXXXX-XXXXXXXX-XXXXXXXX

 QTY: XXXXXXXXXXX HUE: XXXXXXXXXXX

 CAT: XXXXXXXXXXX REF: XXXXXXXXXXX

 REFERENCE: XXXXXXXXXXXXXXXX

 MSL-X MADE IN XXXXXX



- CPN:Customer's Product Number
- P/N:Everlight Product Number
- LOT NO:Lot Number
- QTY:Packing Quantity
- CAT:Luminous Flux (Brightness) Bin
- HUE:Color Bin
- REF:Forward Voltage Bin
- REFERENCE:Reference
- MSL-X:MSL Level

Carrier Tape Dimensions: Loaded Quantity 3000 pcs Per Reel

(Minimum Package Quantity :1000 PCS)

Progress Direction

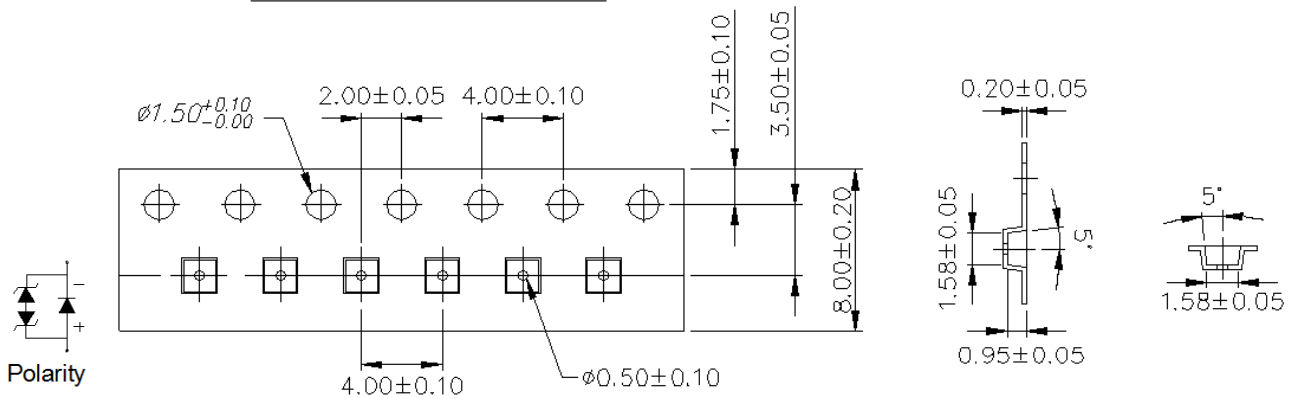

Notes:

1. Dimensions are in millimeters.

Emitter Reel Dimensions

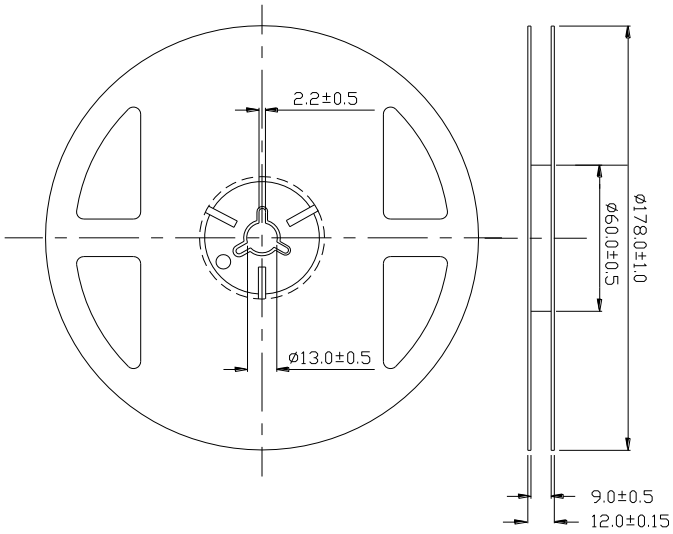

Notes:

1. Dimensions are in millimeters.

Moisture Resistant Packing Process

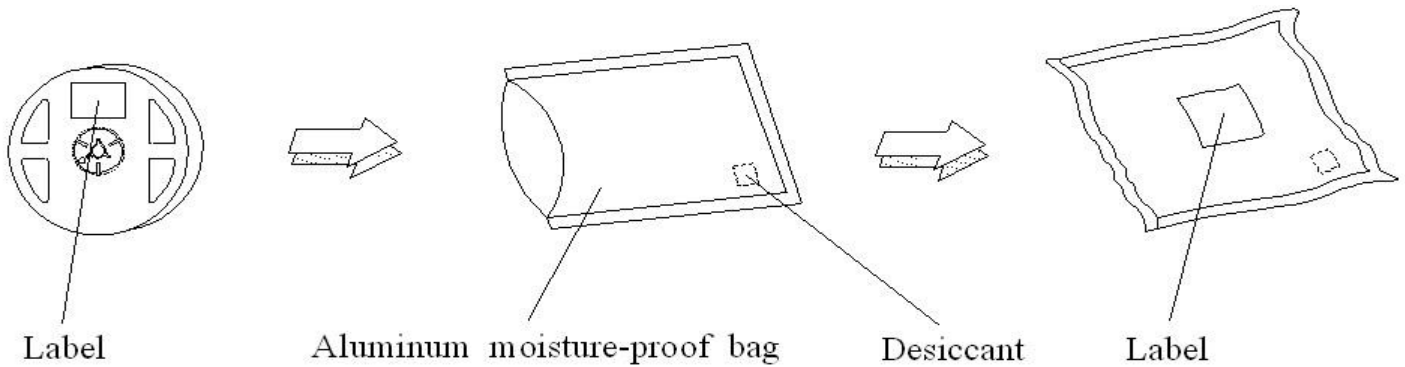

Reflow Soldering Characteristics

Soldering and Handling

1. Over-current-proof

Though CS series has conducted ESD protection mechanism, customers must not use the device in reverse and should apply resistors for extra protection. Otherwise, slight voltage shift may cause enormous current shift and burn out failure would happen.

2. Storage

- 2.1 Do not open the moisture proof bag before the products are ready to use.
- 2.2 Before opening the package, the LEDs should be stored at temperature less than 30°C and relative humidity less than 90%
- 2.3 After opening the package, the LEDs should be stored at temperature less than 30°C and relative humidity less than 85%.
- 2.4 If the moisture absorbent material (silicone gel) has faded away or the LEDs have exceeded the storage time, baking treatment should be implemented based on the following conditions: Pre-curing at 60±5°C for 24 hours.

3. Thermal Management

- 3.1 For maintaining the high flux output and achieving reliability, CS series LEDs should be mounted on a metal core printed circuit board (MCPCB), with proper thermal connection to dissipate approximately 1W to 5W of thermal energy under normal operation.
- 3.2 Sufficient thermal management must be conducted, or the die junction temperature will be over the limit under large electronic driving and LEDs lifetime will decrease critically.
- 3.3 When operating, the solder pad temperature (or the board temperature nearby the LED) must controlled under 70°C.

4. Soldering Condition

4.1 Soldering Pad

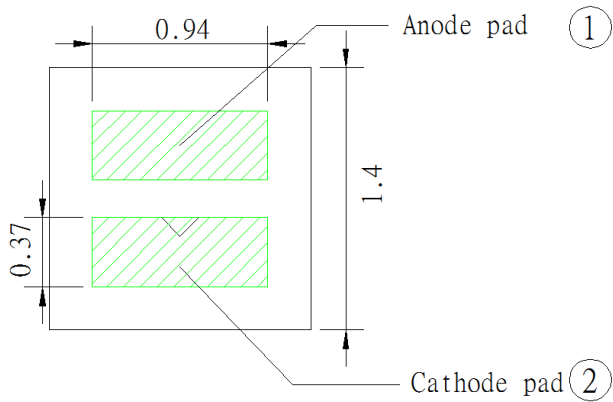

Soldering pattern

4.2 For Reflow Process

4.2.1 Lead reflow soldering temperature profile

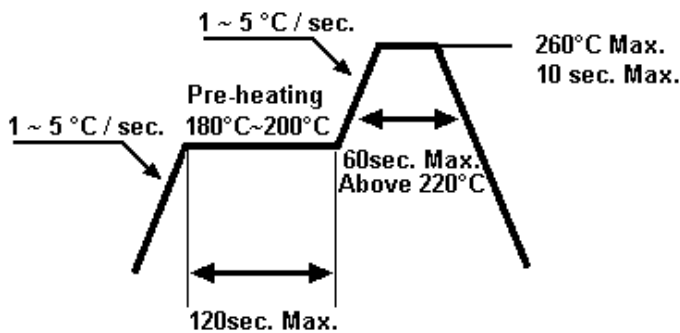

4.2.2 Reflow soldering should not be done more than two times.

4.2.3 While soldering, do not put stress on the LEDs during heating.

4.2.4 After soldering, do not warp the circuit board.

DISCLAIMER

1. EVERLIGHT reserves the right(s) on the adjustment of product material mix for the specification.
2. The product meets EVERLIGHT published specification for a period of twelve (12) months from date of shipment.
3. The graphs shown in this datasheet are representing typical data only and do not show guaranteed values.
4. When using this product, please observe the absolute maximum ratings and the instructions for using outlined in these specification sheets. EVERLIGHT assumes no responsibility for any damage resulting from the use of the product which does not comply with the absolute maximum ratings and the instructions included in these specification sheets.
5. These specification sheets include materials protected under copyright of EVERLIGHT. Reproduction in any form is prohibited without obtaining EVERLIGHT's prior consent.
6. This product is not intended to be used for military, aircraft, automotive, medical, life sustaining or life saving applications or any other application which can result in human injury or death. Please contact authorized Everlight sales agent for special application request.